

Signature™ MS2781B

High Performance Signal Analyzer
100 Hz to 8 GHz

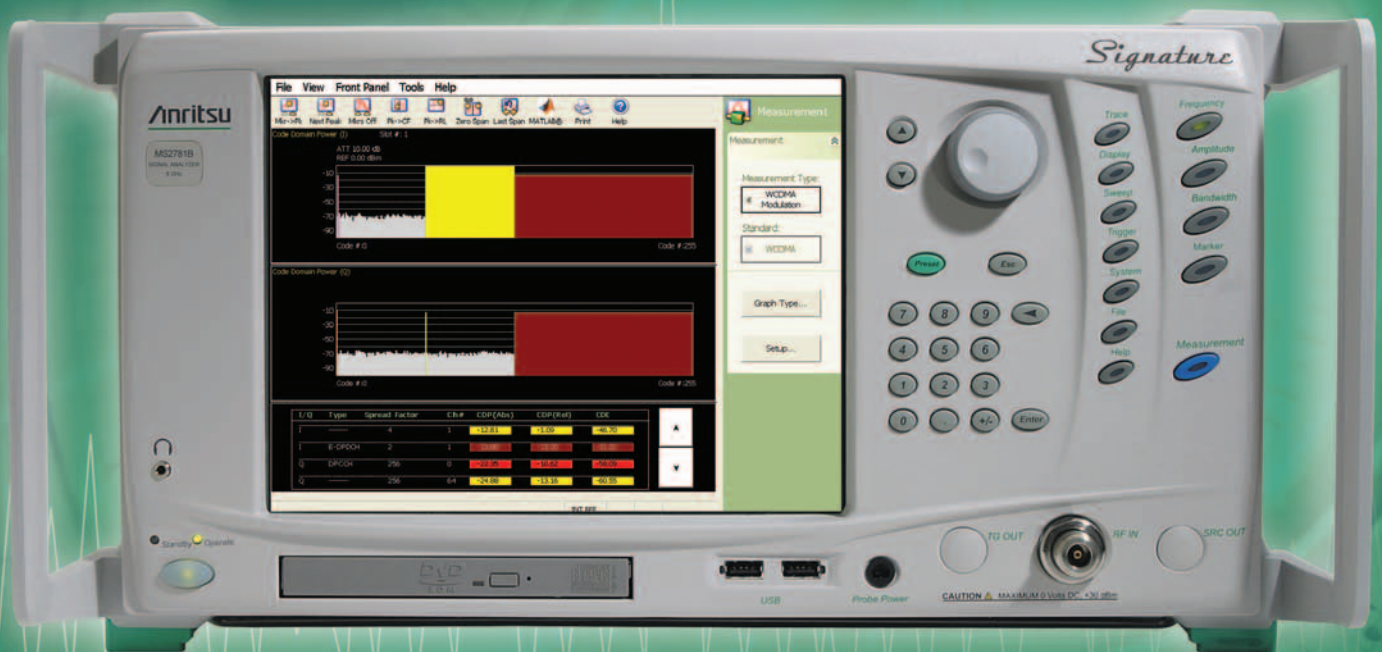

...Now with WCDMA, HSDPA / HSUPA, and WiMAX Modulation Analysis

Anritsu Signature High Performance Signal Analyzer

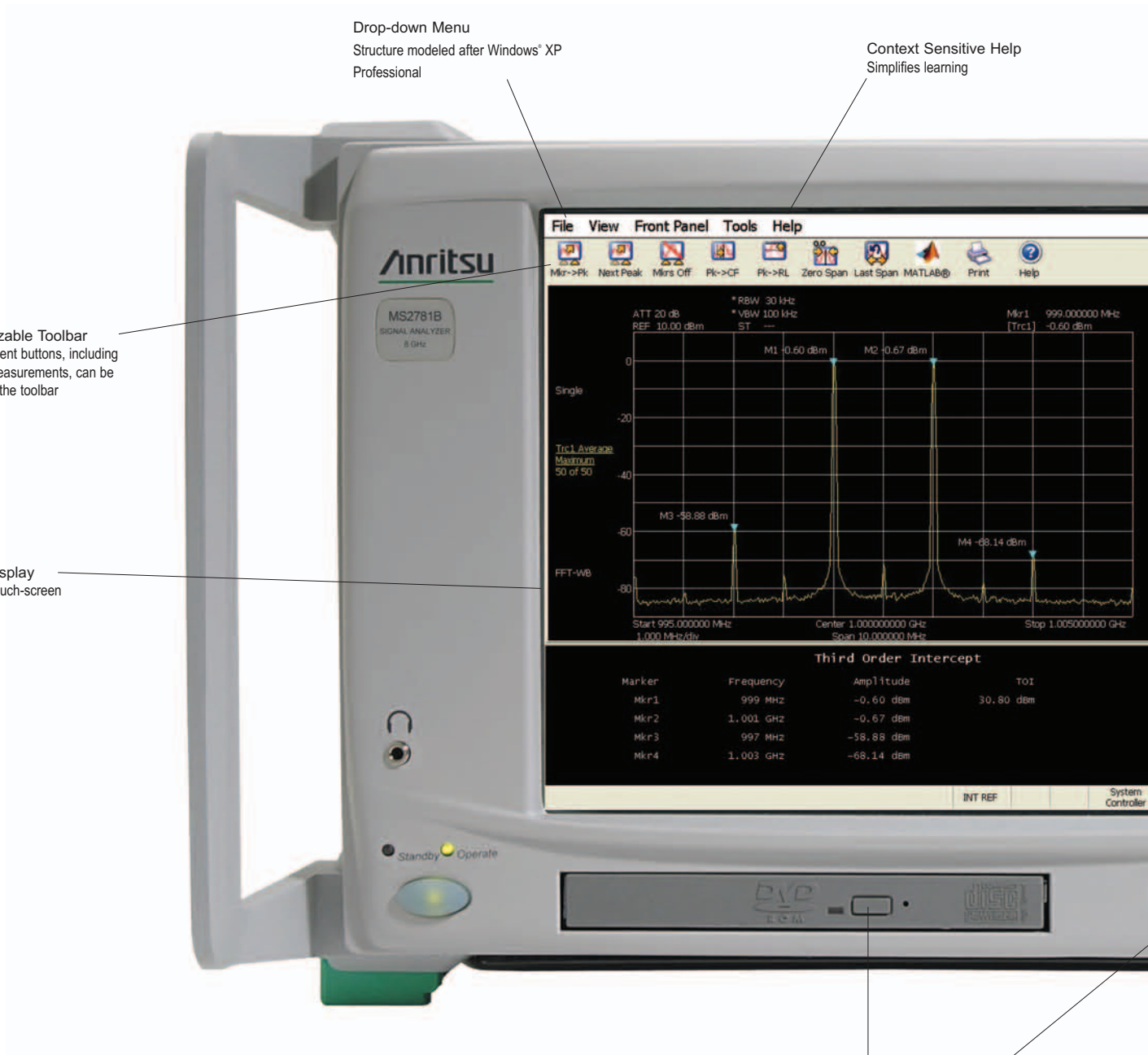

Drop-down Menu
Structure modeled after Windows® XP Professional

Context Sensitive Help
Simplifies learning

Customizable Toolbar
Measurement buttons, including "Smart" measurements, can be placed on the toolbar as needed

Large Display
26.7 cm touch-screen (10.5 inch)

CD-RW+DVD-ROM Drive and USB interfaces
For enhanced connectivity



WiMAX Measurements
Measures both Mobile and Fixed WiMAX devices

WCDMA & HSDPA/HSUPA
Complete suite of Node B measurements for verifying base station transmitters and handsets

Front-panel Keys
Back-lit when activated to facilitate easy operation

Front Panel
Logical and clear layout provides intuitive and easy-to-use interface

Collapsible Menus
Optimized for touch-screen operation. Menus can be minimized to facilitate easy operation.

Improved Engineering Insight for Advanced RF and Communications

Engineers developing the next generation of communications technology need test solutions that do more than just measure signals. New communications and modulation formats require powerful analysis capabilities. Engineers can optimize designs more efficiently when they have simulation and analysis tools integrated with their test equipment. Insight and discovery occur sooner when the instrument is easy to use. The Signature High Performance Signal Analyzer can help make tomorrow's communication systems a reality today.



Anritsu Experience

Anritsu's legacy as a leading provider of communications solutions extends back more than 100 years. Always striving for continued excellence, Anritsu merged with the microwave instrument expert Wiltron Company in 1990. The combined product lines have earned many new product awards. The Signature High Performance Signal Analyzer continues Anritsu's legacy of high performance microwave and communications test solutions.

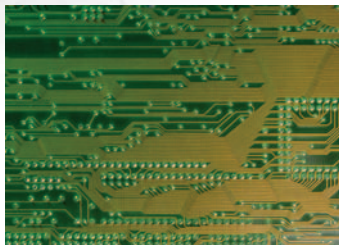

Designing for Customer Needs

Engineers wanted a more powerful, complete and synergistic signal analysis solution. Anritsu developed Signature to meet this need, seeking the advice of leading customers throughout the design process. At each planning and prototype phase, the Anritsu development team gathered extensive feedback from customers around the world. The resulting Signature High Performance Signal Analyzer facilitates the communications technology development process from simulation through signal analysis in a single, easy-to-use, high-performance instrument.

The New Plateau for Performance Signal Analyzers

Signature brings performance signal analyzers to a new plateau. No other signal analyzer matches the spectrum analysis performance of Signature's unique architecture. Simulation and analysis tools such as MATLAB® and Simulink® operate seamlessly with analyzer measurements in the first open Windows environment for a signal analyzer. Built-in "Smart" measurements and personalities for Phase Noise, WiMAX, WCDMA/HSDPA/HSUPA, and QAM/PSK Modulation Analysis ease measurements on complex signals. Engineers can now easily move between simulation, measurement and analysis to support development of new or proprietary communication systems.

- Fundamentally mixed, single band architecture covers 100 Hz to 8 GHz.
- Capture and analyze complex modulated signals with up to 50 MHz bandwidth.
- Use the touch-screen display to perform "smart" measurements by pressing a single button on the front panel.
- Access any function in the intuitive Windows XP Professional environment.



Reduce design cycles and improve confidence.



Elevate product quality and accelerate time to market.

Next-Generation Measurement Performance

New RF components and communications systems are stretching the limits of today's spectrum analyzers. Seeing the power in adjacent channels requires better dynamic range. New communications and modulation formats require greater bandwidth.



Signature is designed to provide exceptional performance as an RF spectrum analyzer and as an ultra-wide bandwidth vector signal analyzer.

Anritsu's leadership position in high performance microwave signal generators provides the technology to choose a higher frequency and wider span in the first local oscillator (LO). This 9.5 to 17.5 GHz LO allows the 100 Hz to 8 GHz measurement frequency range to be covered in one sweep, without switching bands or requiring preselection.

Signature's advanced RF block diagram contributes to the exceptional performance: +22 dBm TOI, -157 dBm DANL, and 0.65 dB amplitude accuracy.

Signature's RF Block Diagram
(L.O. frequencies are nominal values)

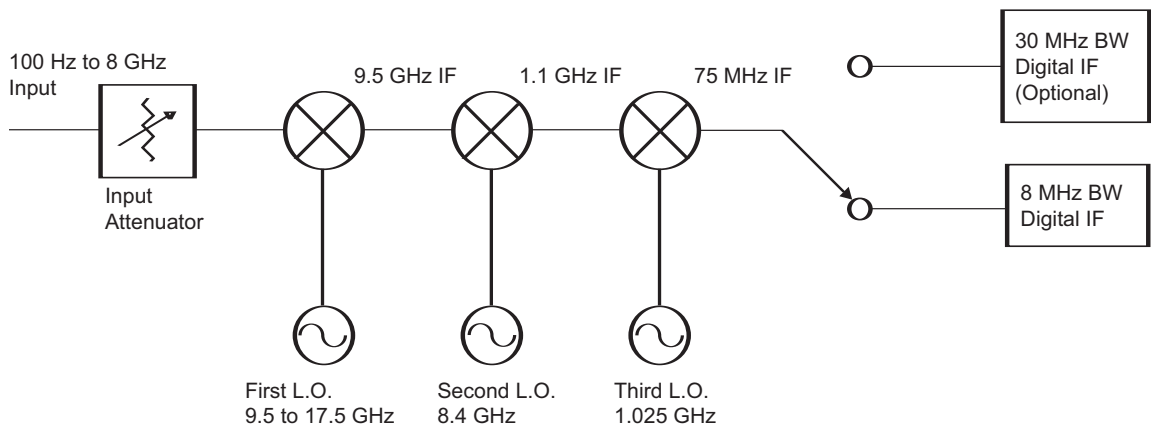

Measurement Performance Specifications¹

Measurement Performance Specifications Summary

Frequency	Frequency Range	100 Hz to 8 GHz
	Resolution Bandwidths	0.1 Hz to 8 MHz
	1 GHz Phase Noise	<-116 dBc/Hz at 100 kHz <-142 dBc/Hz at 5 MHz
Amplitude	Amplitude Accuracy	<0.65 dB over 100 Hz to 8 GHz
	TOI	>+22 dBm
	DANL	<-167 dBm at 1 GHz (0.1 Hz RBW)
WCDMA and HSDPA/HSUPA Modulation Analysis (Option 30 required)	Composite EVM	Floor: 1% Uncertainty: 2%
	Link Direction	Downlink and Uplink
	Code-Domain Power	Floor: -50 dB Uncertainty: 0.1 to 0.3 dB
	Modulation Measurements	EVM (RMS, Peak, and Peak Position) Magnitude and Phase Error IQ Offset, Carrier Frequency Offset Scramble Code (automatically determined) Channel Power (with or without RRC filtering) Primary, Secondary, and Total Sync Channel (SCH) Power Peak Code-Domain Error (PCDE) Bitstream
	Modulation Graphs	Constellation, Vector Diagrams Power, EVM, Magnitude Error, Phase Error, all versus Time Eye Diagrams Code-Domain Power (with and without Zoom) Code-Domain Error (with and without Zoom)
	RF Measurements	Channel Power ACLR Multi-Carrier Power Occupied Bandwidth CCDF Spectrum Masks
QAM/PSK Digital Modulation (Option 38 required)	EVM	1.25% 0.1 to 6 MHz
		2% 6 to 15 MHz
		2.5% 15 to 20 MHz
WiMAX and WiBro Modulation Analysis (Option 41 and Option 22 required)	Mobile and Fixed RCE (EVM)	46 dB
Phase Noise Measurement (Option 52 required)	Offsets	10 Hz to 100 MHz
Operating System		Windows XP Professional
Connectivity	Remote programmable interfaces	GPIB / SCPI commands Ethernet (1000BASE-T) with Web Services
Design and Analysis Software		Interoperability with Microsoft Office, and MATLAB
User Interfaces		Touch-Screen, mouse, keyboard

¹ See the MS2781B Technical Data Sheet for more detail.

Phase Noise Measurements

A key performance metric of oscillators is phase noise.

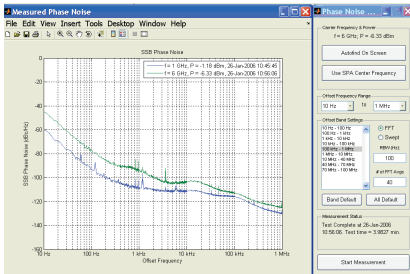

1. Measure the phase noise at one offset frequency using markers in Spectrum display.
2. Measure phase noise versus offset frequency with a graphical display using Option 52, Phase Noise Measurements. The offset range, sweep type (FFT or swept), and amount of averaging are all adjustable by decade. Multiple measurements can be overlaid, in color, to help compare device performance under various conditions such as carrier frequency, bias voltage, or temperature.

Operating System

Signature is the first high performance spectrum analyzer to fully exploit the power of an open Windows XP Professional operating system. The benefits are clear: faster results for both design and manufacturing teams.

- 1 Familiar drop-down menus supplement hard keys for mouse-driven or remote operation

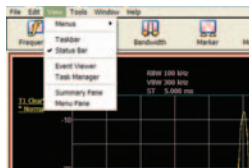

- 3 A familiar language such as Visual Basic™ can be installed on Signature to customize the instrument

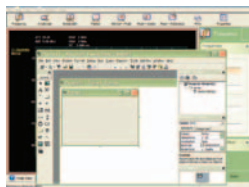

- 2 Customizable windows toolbar optimizes your workflow



- 4 Use Microsoft Office software to easily prepare reports

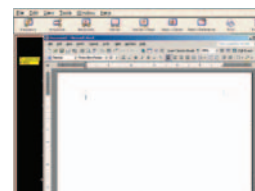

Accessible Insight

Never has a Signal Analyzer with this much power been this simple to use!

Performance alone does not lead to engineering insight. Signature offers a more modern user platform to make its performance readily available when and where it is needed.



Microsoft Windows plus Touch Screen Look and Feel

The menu structure in Signature is modeled after Windows XP Professional to facilitate learning. Menus are also optimized for touch-screen operation with single-click activation.

Front panel keys are back-lit to indicate that an entry is needed. A menu can be activated simply by touching the annotation.

For rack mount and remote applications, a user can access and operate all functions with the mouse.

“Smart” Signal Analyzer Measurements

“Smart” one-button functions are available for many commonly needed measurements, e.g. Channel Power, ACP, CCDF, and OBW

Customizable Toolbar

The Windows toolbar may be customized to include frequently used basic measurements or functions.

Advanced Analysis

Engineering insight often requires further analysis. MATLAB & Simulink from The MathWorks provide an easy way to do this analysis, even directly on the instrument.

Applications such as measuring chirp frequency linearity, or EVM versus power can be addressed with just a few lines of MATLAB code.

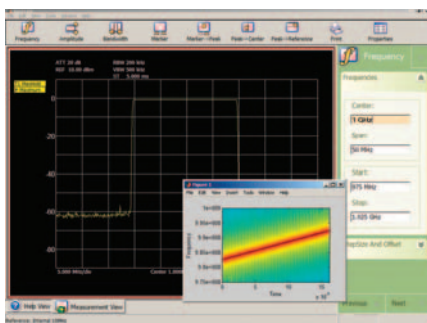

Signature setup information and measurements (including traces and IQ vectors) are automatically available in MATLAB when installed on the instrument. Up to 10 million I/Q vectors can be captured and transferred to MATLAB in a few seconds.

Deeper Insight into Digitally Modulated Signals

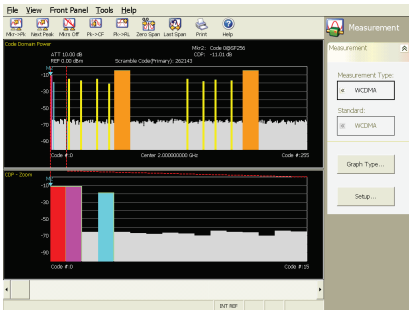

Code Domain Power with Zoom

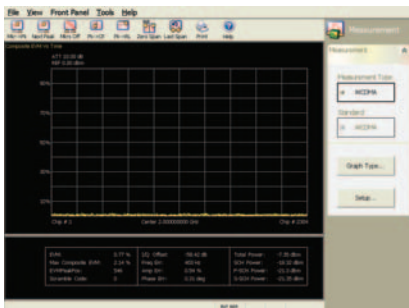

WCDMA Composite EVM vs. Time with Composite Summary

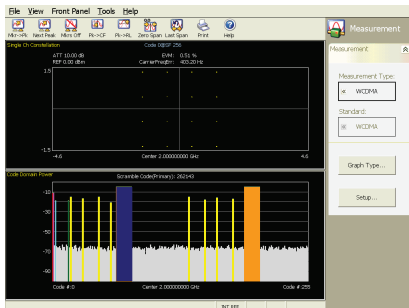

Constellation Diagram of an HSDPA Code with Code Domain Power Overview

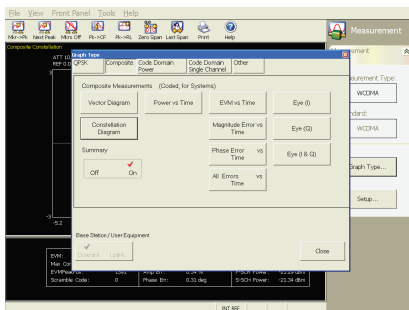

Simplified user interface for WCDMA Measurements

In addition to high performance spectrum analysis, Signature can analyze a wide variety of digitally modulated signals without the need for a separate computer. Gain insight into your transmitter with the powerful analysis in Signature.

WCDMA/HSDPA/HSUPA Measurements

Gain insight into your WCDMA device by making modulation quality measurements. With Option 30, you can make Code Domain Power, EVM versus time, Constellation Diagram, Composite EVM and many other measurements at the touch of a button. A simplified interface gives accessible insight, while retaining all the power you expect in a high performance signal analyzer. RF measurements of Channel Power, ACLR (Adjacent Channel Leakage power Ratio), Multi-carrier Channel Power, CCDF (Complementary Cumulative Distribution Function), and Spectrum Masks are also available to help you understand the RF performance of your device.

QAM/PSK Modulated Signals

Option 38, General Purpose QAM/PSK Modulation Analysis, allows you to select the symbol rate, modulation type, and filtering methods to demodulate captured signals. Symbol table, constellation, and vector diagrams allow viewing of the data stream. Standard measurements are available to measure EVM, carrier leakage and I/Q imbalance.

WiMAX and WiBro Measurements

Insight into your WiMAX or WiBro device is just a few button pushes away. With option 41, you can make modulation quality measurements such as Relative Constellation Error (RCE), IQ Offset and Carrier Frequency Offset, as well as display Constellation diagrams and RCE versus sub-carrier or symbol.

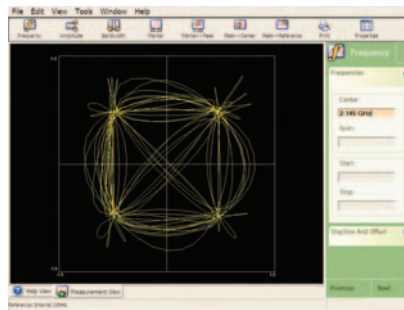

Vector Diagram of QPSK modulation

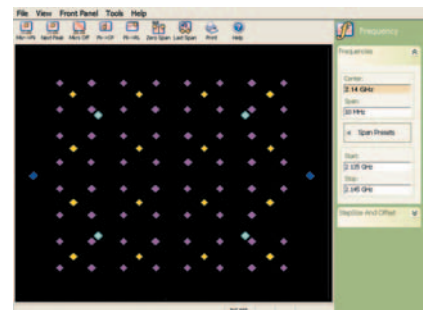

Constellation of Mobile WiMAX signal showing multiple modulation types simultaneously.

Advanced Connectivity to Today's Environment

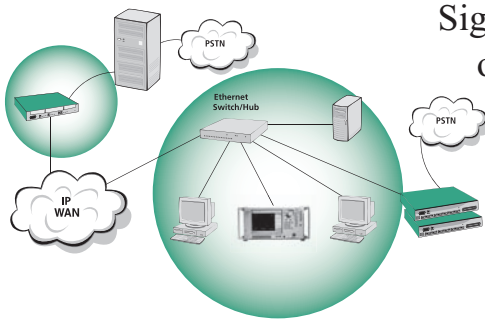

Signature offers an unprecedented range of connectivity options to support modern design and manufacturing environments. Signature is the first high performance spectrum analyzer to fully exploit the power of Windows XP Professional. The benefits are clear: faster results for both design and manufacturing teams.

GPIB

Signature offers a GPIB interface and SCPI command set for classic ATE environments. Signature can also act as a GPIB controller to drive other instruments in a system.

USB

USB host ports on both the front and rear panels allow easy addition of Windows-compliant accessories such as a mouse, keyboard, disk drive, barcode reader, memory stick, WLAN interface, printer, or camera.



MA24106A
USB Power Sensor

The MS2781B with full functioning CPU and USB connectivity fully supports USB accessories, such as Anritsu's MA24106A USB Power Sensor. Supporting software and drivers are preinstalled on MS2781B Signature Signal Analyzers. The Signature is "Plug and Play" ready for highly accurate power measurements within frequency range of the power sensor.

For further information on the MA24106A Power Sensor, see the Anritsu product brochure "USB Power Sensor MA24106A" part number: 11410-00424.

Ethernet

The 1000BASE-T Ethernet interface allows remote access to all of the resources in Signature via LAN/Internet. The Windows XP Professional operating system allows your network to configure Signature the same way as other Windows clients on your LAN.

Web-Based Automation

LAN/Internet remote command automation is facilitated by Signature's use of Web Services. This platform and software-independent interface provides access to all Signature hardware and software functionality via the Ethernet connection. A web browser can view and control Signature settings functionality. SCPI commands can be used to provide a GPIB-like remote program control. Web Services compatible development software such as c#.NET can operate with Signature Web Services to greatly simplify the development of remote programs.

Computer-specific driver software is no longer needed. GPIB & SCPI commands can also be sent via Ethernet, without need for Option 3. Signature is VXI-11 compatible and LXI ready.

Web Remote Operation

Web-based remote operation is easily accomplished using Windows NetMeeting, remote application software like pcAnywhere™ or a web conferencing resource like WebEx™.

Easy access to trace information

All Signature displays, including live traces, are created in the Windows environment, simplifying incorporation of test results into Microsoft Office tools such as Excel, Word and Powerpoint. The built-in printer port supports hard copy needs.

Signal Generation and Analysis for Complete Testing

Signature and the Anritsu MG3700A Vector Signal Generator make a powerful combination. Together they give ultimate flexibility for making measurements with proprietary or new modulation types, such as 802.11n or Software-Defined Radio (SDR).

A signal captured with Signature can be downloaded to the MG3700A. This provides a way to replay a signal for troubleshooting or interoperability testing. Then for margin testing, impairments can be added – either in software or directly on the generator.

Proprietary or new modulation types can be created using a software tool such as MATLAB. Waveforms can then be downloaded to the MG3700A for receiver testing. Impairments are again easily added. These modulated waveforms can then be captured and analyzed using Signature and MATLAB. This combination of Signature, MG3700A and MATLAB allows easy testing of transmitters and receivers, as well as verification of software transmitter and receiver models in a real-world environment.



ANRITSU Corporation

5-1-1 Onna, Atsugi-shi, Kanagawa, 243-8555 Japan
Phone: +81-46-223-1111
Fax: +81-46-296-1264

- U.S.A.

ANRITSU Company

1155 East Collins Boulevard, Suite 100,
Richardson, Texas 75081
Toll Free: 1-800-ANRITSU (267-4878)
Phone: +1-972-644-1777
Fax: +1-972-671-1877

- Canada

ANRITSU Electronics Ltd.

700 Silver Seven Road, Suite 120, Kanata,
Ontario K2V 1C3, Canada
Phone: +1-613-591-2003
Fax: +1-613-591-1006

- Brazil

ANRITSU Eletrônica Ltda.

Praca Amadeu Amaral, 27-1 andar
01327-010 - Paraisópolis, São Paulo, Brazil
Phone: +55-11-3283-2511
Fax: +55-11-3886940

- U.K.

ANRITSU EMEA Ltd.

200 Capability Green, Luton, Bedfordshire LU1 3LU, U.K.
Phone: +44-1582-433280
Fax: +44-1582-731303

- France

ANRITSU S.A.

9, Avenue du Québec Z.A. de Courtaboeuf
91951 Les Ulis Cedex, France
Phone: +33-1-60-92-15-50
Fax: +33-1-64-46-10-65

- Germany

ANRITSU GmbH

Nemetschek Haus, Konrad-Zuse-Platz 1
81829 München, Germany
Phone: +49 (0) 89 442308-0
Fax: +49 (0) 89 442308-55

- Italy

ANRITSU S.p.A.

Via Elio Vittorini, 129, 00144 Roma, Italy
Phone: +39-06-509-9711
Fax: +39-06-502-2425

- Sweden

ANRITSU AB

Borgafjordsgatan 13, 164 40 Kista, Sweden
Phone: +46-8-534-707-00
Fax: +46-8-534-707-30

- Finland

ANRITSU AB

Teknobulevardi 3-5, FI-01530 Vantaa, Finland
Phone: +358-20-741-8100
Fax: +358-20-741-8111

- Denmark

ANRITSU A/S

Kirkebjerg Allé 90 DK-2605 Brøndby, Denmark
Phone: +45-72112200
Fax: +45-72112210

- Spain

Anritsu EMEA Ltd.

Oficina de Representación en España

Edificio Veganova
Avda de la Vega, nº 1 (edf 8, pl1, of 8)
28108 ALCOBENDAS - Madrid, Spain
Phone: +34-914905761
Fax: +34-914905762

- United Arab Emirates

ANRITSU EMEA Ltd.

Dubai Liaison Office

P O Box 500413 - Dubai Internet City
Al Thuraya Building, Tower 1, Suite 701, 7th Floor
Dubai, United Arab Emirates
Phone: +971-4-3670352
Fax: +971-4-3688460

- Singapore

ANRITSU Pte. Ltd.

60 Alexandra Terrace, #02-08, The Comtech (Lobby A)
Singapore 118502
Phone: +65-6282-2400
Fax: +65-6282-2533

- India

ANRITSU Pte. Ltd.

India Liaison Office

Unit No.S-3, Second Floor, Esteem Red Cross Bhavan,
No.26, Race Course Road, Bangalore 560 001 India
Phone: +91-80-32944707
Fax: +91-80-22356648

- P. R. China (Hong Kong)

ANRITSU Company Ltd.

Units 4 & 5, 28th Floor, Greenfield Tower, Concordia Plaza,
No. 1 Science Museum Road, Tsim Sha Tsui East,
Kowloon, Hong Kong, P.R. China
Phone: +852-2301-4980
Fax: +852-2301-3545

- P. R. China (Beijing)

ANRITSU Company Ltd.

Beijing Representative Office

Room 1515, Beijing Fortune Building,
No. 5, Dong-San-Huan Bei Road,
Chao-Yang District, Beijing 100004, P.R. China
Phone: +86-10-6590-9230
Fax: +82-10-6590-9235

- Korea

ANRITSU Corporation, Ltd.

8F Hyunjuk Bldg. 832-41, Yeoksam-Dong,
Kangnam-ku, Seoul, 135-080, Korea
Phone: +82-2-553-6603
Fax: +82-2-553-6604

- Australia

ANRITSU Pty Ltd.

Unit 21/270 Ferntree Gully Road, Notting Hill
Victoria, 3168, Australia
Phone: +61-3-9558-8177
Fax: +61-3-9558-8255

- Taiwan

ANRITSU Company Inc.

7F, No. 316, Sec. 1, Neihsu Rd., Taipei 114, Taiwan
Phone: +886-2-8751-1816
Fax: +886-2-8751-1817

Ordering Information

Order Number	Description
MS2781B	100 Hz to 8 GHz High Performance Signal Analyzer

Options (See the MS2781B Technical Data Sheet for more detail.)

MS2780/3	GPIB Interface
MS2780/4	External Hard Disk Drive
MS2780/22	30 MHz Demodulation Bandwidth (includes baseband differential I & Q inputs)
MS2780/30	WCDMA and HSDPA Modulation Analysis
MS2780/38	QAM/PSK Modulation Analysis
MS2780/40	Connectivity to MATLAB
MS2780/41	WiMAX Modulation Analysis Supports IEEE 802.16d/e OFDM/OFDMA with compliance to WiBro (requires Option 22)
MS2780/52	Phase Noise Measurements
MS2780/98	Standard calibration to ISO17025 and ANSI/NCSL Z540
MS2780/99	Premium calibration to ISO17025 and ANSI/NCSL Z540
Es50MMD	Extends warranty to 5 years

Please Contact:

